

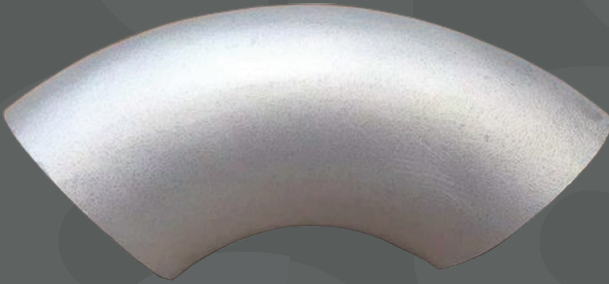

COPPERAGE
韵 澜 金 属

Aluminum BW Elbows

SR/LR Elbows of 45°, 90° and 180°



Yingtan Winland Metallurgy Co., Ltd.

sales@copperage.net

Yingtan, China



INTRODUCTION

COPPERAGE™ is a fittings brand launched by Yingtan Winland Metallurgy Co., Ltd., we supply copper, aluminum steel and other fittings for clients all over the world.

This catalog covers 45deg,90deg and 180deg elbows, which are wrought buttwelding fittings made from 6010/6061/6063 aluminum alloys. The brass is made of brass copper.

CUSTOMIZATION

We understand there are many special demands for client's projects, you may need to customize the aluminum elbows.

You are welcome to send us a sample or drawings, we'll see what we can do. Sampling cost will be collected, please email us at sales@copperage.net for more details.



QUALITY

*stable quality products for
high end pipelines*

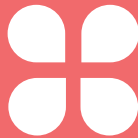

PRODUCTS

*wide range of products to
meet client's demand*



CUSTOMIZE

*tailored dimensions for
special need*

90DEG LR ELBOW

Material: 6010/6061/6063

Wrought aluminum long radius return, 90 degree bend. Equal dimensions at two butt welding ends.

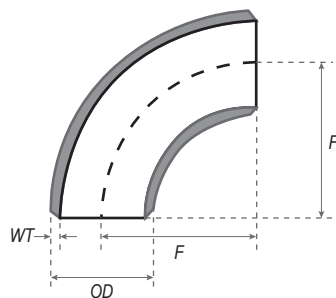

Part No.	Nominal Pipe Size (NPS)	Outside Diameter at Bevel	Center-to-End F
CA51W1121	1/2	21.3mm	38.1mm
CA51W1122	3/4	26.7mm	38.1mm
CA51W1123	1	33.4mm	38.1mm
CA51W1124	1-1/4	42.2mm	47.8mm
CA51W1125	1-1/2	48.3mm	57.2mm
CA51W1126	2	60.3mm	76.2mm
CA51W1127	2-1/2	73mm	95.2mm
CA51W1128	3	88.9mm	114.3mm
CA51W1129	3-1/2	101.6mm	133.4mm
CA51W1130	4	114.3mm	152.4mm
CA51W1131	5	141.3mm	100.5mm
CA51W1132	6	168.3mm	228.6mm
CA51W1133	8	219.1mm	304.8mm
CA51W1134	10	273mm	381mm
CA51W1135	12	323.8mm	457.2mm
CA51W1136	14	355.6mm	533.4mm
CA51W1137	16	406.4mm	609.6mm
CA51W1138	18	457.2mm	685.8mm
CA51W1139	20	508mm	762mm
CA51W1140	22	558.8mm	838.2mm
CA51W1141	24	609.6mm	914.4mm

Part No.	Nominal Pipe Size (NPS)	Outside Diameter at Bevel	Center-to-End F
CA51W1142	26	660.4mm	990.6mm
CA51W1143	28	711.2mm	1066.8mm
CA51W1144	30	762mm	1143mm
CA51W1145	32	812mm	1219.2mm
CA51W1146	34	863.6mm	1295.4mm
CA51W1147	36	914.4mm	1371.6mm
CA51W1148	38	965.2mm	1447.8mm
CA51W1149	40	1016mm	1524mm
CA51W1150	42	1066.8mm	1600.2mm
CA51W1151	44	1117.6mm	1676.4mm
CA51W1152	46	1068.4mm	1752.6mm
CA51W1153	48	1219.2mm	1828.8mm
CA51W1154	52	1320.8mm	
CA51W1155	54	1371.6mm	2057.4mm
CA51W1156	56	1422.4mm	2133.6mm
CA51W1157	60	1524mm	2286mm
CA51W1158	66	1676.4mm	2514.6mm
CA51W1159	68	1727mm	2591mm
CA51W1160	72	1829mm	2743mm
CA51W1161	76	1930mm	2896mm
CA51W1162	80	2032mm	3048mm



90DEG SR ELBOW

Material: 6010/6061/6063

Wrought aluminum short radius return, 90 degree bend. Equal dimensions at two butt welding ends.

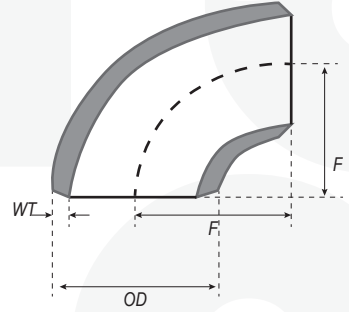

Part No.	Nominal Pipe Size (NPS)	Outside Diameter at Bevel	Center-to-End F
CA51W2233	1	33.4mm	25.4mm
CA51W2234	1-1/4	42.2mm	31.8mm
CA51W2235	1-1/2	48.3mm	38.1mm
CA51W2236	2	60.3mm	50.8mm
CA51W2237	2-1/2	73mm	63.5mm
CA51W2238	3	88.9mm	76.2mm
CA51W2239	3-1/2	101.6mm	88.9mm
CA51W2240	4	114.3mm	101.6mm
CA51W2241	5	141.3mm	127.0mm
CA51W2242	6	168.3mm	152.4mm
CA51W2243	8	219.1mm	208.2mm
CA51W2244	10	273.1mm	254.0mm
CA51W2245	12	323.8mm	304.8mm
CA51W2246	14	355.6mm	355.6mm
CA51W2247	16	406.4mm	406.4mm
CA51W2248	18	457.2mm	457.2mm
CA51W2249	20	508.0mm	508.0mm
CA51W2250	22	558.8mm	558.8mm

Part No.	Nominal Pipe Size (NPS)	Outside Diameter at Bevel	Center-to-End F
CA51W2251	24	609.6mm	609.6mm
CA51W2252	26	660.4mm	660.4mm
CA51W2253	28	711.2mm	711.2mm
CA51W2254	30	762.0mm	762.0mm
CA51W2255	32	812.8mm	812.8mm
CA51W2256	34	863.6mm	863.6mm
CA51W2257	36	914.4mm	914.4mm
CA51W2258	40	1016.0mm	1016.0mm
CA51W2259	42	1066.8mm	1066.8mm
CA51W2260	44	1117.6mm	1117.6mm
CA51W2261	48	1219.2mm	1219.2mm
CA51W2262	52	1320.8mm	1320.8mm
CA51W2263	54	1371.6mm	1371.6mm
CA51W2264	56	1422.4mm	1422.4mm
CA51W2265	60	1524.0mm	1524.0mm
CA51W2266	68	1727.0mm	1727.0mm
CA51W2267	72	1829.0mm	1829.0mm
CA51W2268	76	1930.0mm	1930.0mm
CA51W2269	80	2032.0mm	2032.0mm



45DEG LR ELBOW

Material: 6010/6061/6063

Wrought aluminum long radius return, 45 degree bend. Equal dimensions at two butt welding ends.

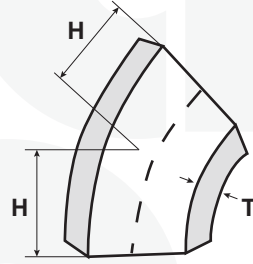

Part No.	Nominal Pipe Size (NPS)	Outside Diameter at Bevel	Center-to-End H
CA51W4603	1/2	21.3mm	15.7mm
CA51W4604	3/4	26.7mm	19.1mm
CA51W4605	1	33.4mm	22.4mm
CA51W4606	1-1/4	42.2mm	25.4mm
CA51W4607	1-1/2	48.3mm	29.4mm
CA51W4608	2	60.3mm	35.1mm
CA51W4609	2-1/2	73.0mm	44.4mm
CA51W4610	3	88.9mm	50.8mm
CA51W4611	3-1/2	101.6mm	57.2mm
CA51W4612	4	114.3mm	63.5mm
CA51W4613	5	141.3mm	79.2mm
CA51W4614	6	168.3mm	95.2mm
CA51W4615	8	219.1mm	127.0mm
CA51W4616	10	273.0mm	158.8mm
CA51W4617	12	323.8mm	190.5mm
CA51W4618	14	355.6mm	222.2mm
CA51W4619	16	406.4mm	254.0mm
CA51W4620	18	457.2mm	285.8mm
CA51W4621	20	508.0mm	317.5mm
CA51W4622	22	558.8mm	342.9mm

Part No.	Nominal Pipe Size (NPS)	Outside Diameter at Bevel	Center-to-End H
CA51W4623	24	609.6mm	381.0mm
CA51W4624	26	660.4mm	406.4mm
CA51W4625	28	711.2mm	438.2mm
CA51W4626	30	762.0mm	469.9mm
CA51W4627	32	812.8mm	501.6mm
CA51W4628	34	863.6mm	533.4mm
CA51W4629	36	914.4mm	565.2mm
CA51W4630	38	965.2mm	599.9mm
CA51W4631	40	1016.0mm	632.0mm
CA51W4632	42	1066.8mm	660.4mm
CA51W4633	44	1117.6mm	695.5mm
CA51W4634	46	1068.4mm	726.9mm
CA51W4635	48	1219.2mm	759.0mm
CA51W4636	54	1371.6mm	852.2mm
CA51W4637	56	1422.4mm	883.8mm
CA51W4638	60	1524.0mm	946.9mm
CA51W4639	66	1676.4mm	1041.6mm
CA51W4640	68	1727.0mm	1073.0mm
CA51W4641	72	1829.0mm	1137.0mm
CA51W4642	76	1930.0mm	1199.0mm
CA51W4643	80	2032.0mm	1263.0mm



45DEG SR ELBOW

Material: 6010/6061/6063

Wrought aluminum short radius return, 45 degree bend. Equal dimensions at two butt welding ends.

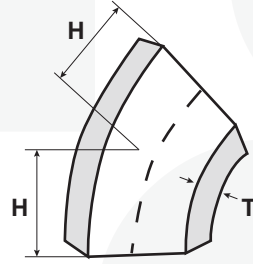

Part No.	Nominal Pipe Size (NPS)	Outside Diameter at Bevel	Center-to-End H
CA51W3428	3	88.9mm	31.6mm
CA51W3429	3-1/2	101.6mm	36.8mm
CA51W3430	4	114.3mm	42.1mm
CA51W3431	5	141.3mm	52.6mm
CA51W3432	6	168.3mm	63.4mm
CA51W3433	8	219.1mm	84.2mm
CA51W3434	10	273.1mm	105.2mm
CA51W3435	12	323.8mm	126.3mm
CA51W3436	14	355.6mm	147.3mm
CA51W3437	16	406.4mm	168.3mm
CA51W3438	18	457.2mm	189.4mm
CA51W3439	20	508.0mm	210.4mm
CA51W3440	22	558.8mm	231.5mm
CA51W3441	24	609.6mm	252.5mm

Part No.	Nominal Pipe Size (NPS)	Outside Diameter at Bevel	Center-to-End H
CA51W3442	26	660.4mm	273.5mm
CA51W3443	28	711.2mm	294.6mm
CA51W3444	30	762.0mm	315.6mm
CA51W3445	32	812.8mm	378.1mm
CA51W3446	34	863.6mm	357.7mm
CA51W3447	36	914.4mm	378.8mm
CA51W3448	40	1016.0mm	420.8mm
CA51W3449	42	1066.8mm	441.9mm
CA51W3450	44	1117.6mm	462.9mm
CA51W3451	48	1219.2mm	505.0mm
CA51W3452	52	1320.8mm	547.1mm
CA51W3453	54	1371.6mm	568.1mm
CA51W3454	56	1422.4mm	589.2mm
CA51W3455	60	1524.0mm	631.3mm



180DEG Return

Material: 6010/6061/6063

Wrought aluminum 180 degree U shape bend return. Equal dimensions at two butt welding ends.

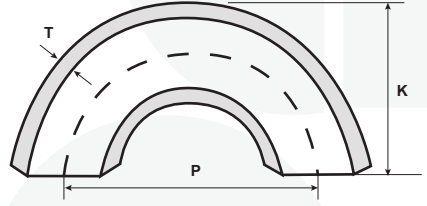

LONG RADIUS

Part No.	Nominal Pipe Size (NPS)	Outside Diameter at Bevel	Center-to-Center p	Center-to-Face K
CA51W5L11	1/2	21.3mm	76.2mm	47.8mm
CA51W5L12	3/4	26.7mm	76.2mm	50.8mm
CA51W5L13	1	33.4mm	76.2mm	55.6mm
CA51W5L14	1-1/4	42.2mm	95.3mm	59.9mm
CA51W5L15	1-1/2	48.3mm	114.3mm	82.6mm
CA51W5L16	2	60.3mm	152.4mm	106.6mm
CA51W5L17	2-1/2	73.0mm	190.5mm	131.8mm
CA51W5L18	3	88.9mm	228.6mm	158.8mm
CA51W5L19	3-1/2	101.6mm	266.7mm	184.2mm
CA51W5L20	4	114.3mm	304.8mm	209.6mm
CA51W5L21	5	141.3mm	381.0mm	261.9mm
CA51W5L22	6	168.3mm	457.2mm	312.7mm
CA51W5L23	8	219.1mm	609.6mm	414.3mm
CA51W5L24	10	273.1mm	762.0mm	517.7mm
CA51W5L25	12	323.9mm	914.4mm	619.3mm
CA51W5L26	14	355.6mm	1066.8mm	711.2mm
CA51W5L27	16	406.4mm	1219.2mm	812.8mm
CA51W5L28	18	457.2mm	1317.6mm	914.4mm
CA51W5L29	20	508.0mm	1524.0mm	1016.0mm
CA51W5L30	22	558.8mm	1676.4mm	1117.6mm
CA51W5L31	24	609.6mm	1828.8mm	1219.2mm

SHORT RADIUS

Part No.	Nominal Pipe Size (NPS)	Outside Diameter at Bevel	Center-to-Center p	Center-to-Face K
CA51W5S13	1	33.4mm	50.8mm	41.1mm
CA51W5S14	1-1/4	42.2mm	63.6mm	52.3mm
CA51W5S15	1-1/2	48.3mm	76.2mm	62.0mm
CA51W5S16	2	60.3mm	101.6mm	81.0mm
CA51W5S17	2-1/2	73.0mm	127.0mm	100.1mm
CA51W5S18	3	88.9mm	152.4mm	120.7mm
CA51W5S19	3-1/2	101.6mm	177.8mm	139.7mm
CA51W5S20	4	114.3mm	203.2mm	158.8mm
CA51W5S21	5	141.3mm	254.0mm	196.9mm
CA51W5S22	6	168.3mm	304.8mm	236.5mm
CA51W5S23	8	219.1mm	406.4mm	312.7mm
CA51W5S24	10	273.1mm	508.0mm	390.7mm
CA51W5S25	12	323.9mm	609.6mm	466.9mm
CA51W5S26	14	355.6mm	711.2mm	533.4mm
CA51W5S27	16	406.4mm	812.8mm	609.6mm
CA51W5S28	18	457.2mm	914.4mm	685.8mm
CA51W5S29	20	508.0mm	1016.0mm	762.0mm
CA51W5S30	22	558.8mm	1117.6mm	838.2mm
CA51W5S31	24	609.6mm	1219.2mm	914.4mm